

PÁRAELSZÍVÓ
SIRIUS villanymotor
220V -240V 50Hz 300W

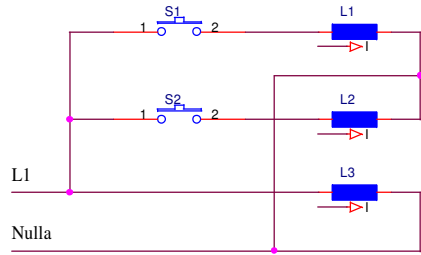

A névlegesnél 2x nagyobb teljesítményt vesz fel.
S1 - jobbra forog
S2 - balra forog

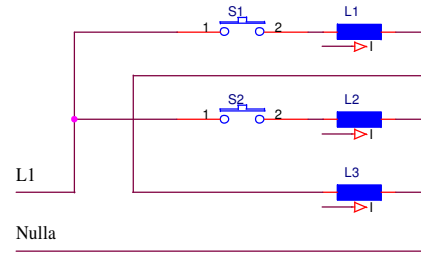

Nem indul!

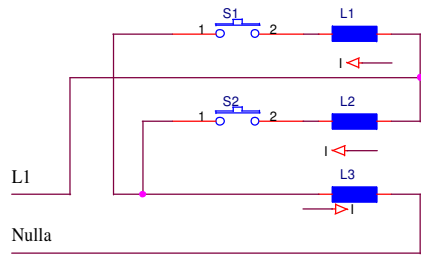

100W-ot vesz fel.
S1 - jobbra forog
S2 - jobbra forog
fordulatszám különbség "szemre" nincs
Indulás bizonytalan!

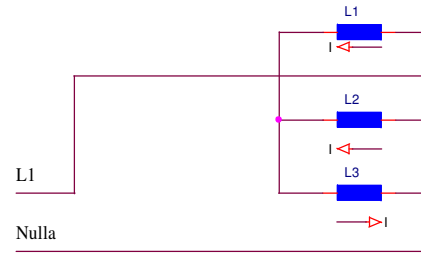

Nem indul!

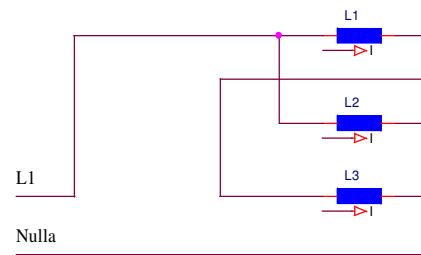

P=300W,nem indul,bűg

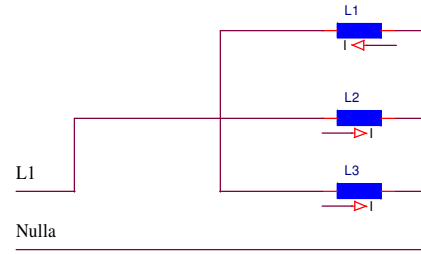

Nem forog!

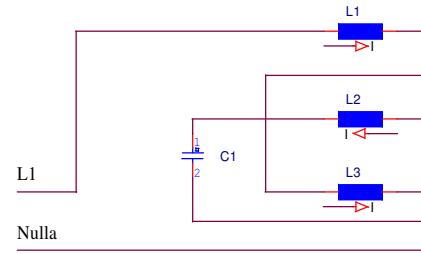

Indul,forog,kb.100W

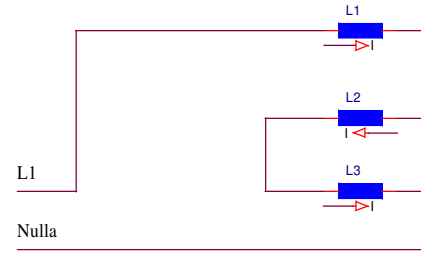

Nem forog!

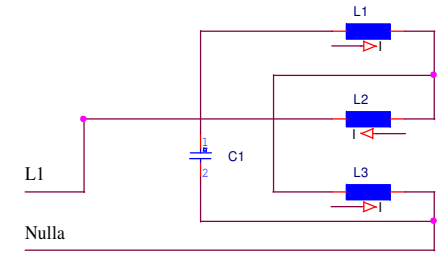
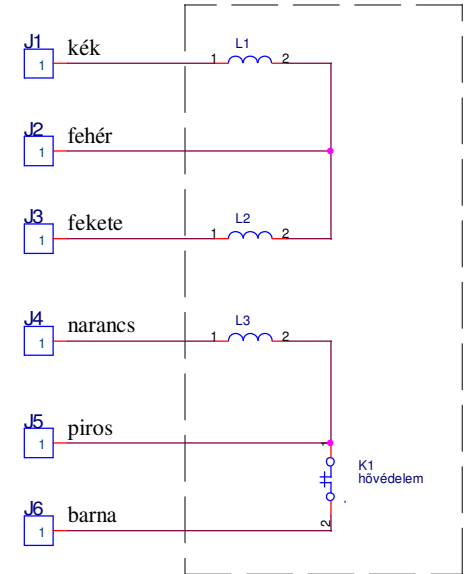

Indul,forog,kb.100W

Title <Title>		
Size B	Document Number <Doc>	Rev 1
Date:	Saturday, April 23, 2011	Sheet 1 of 1